

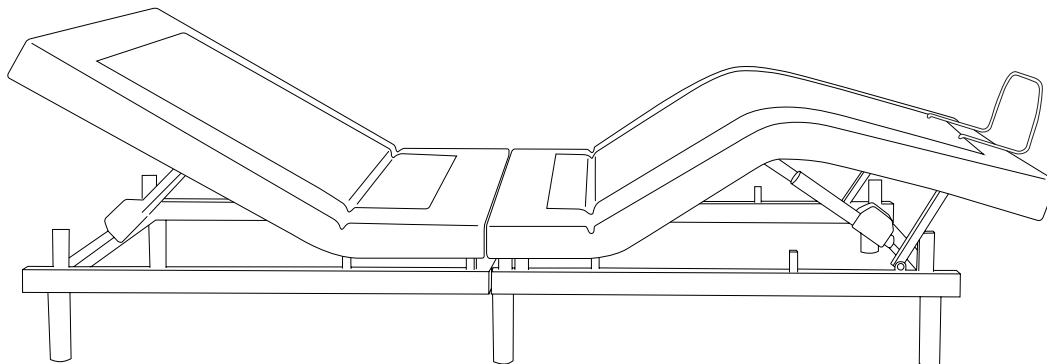

Owners manual

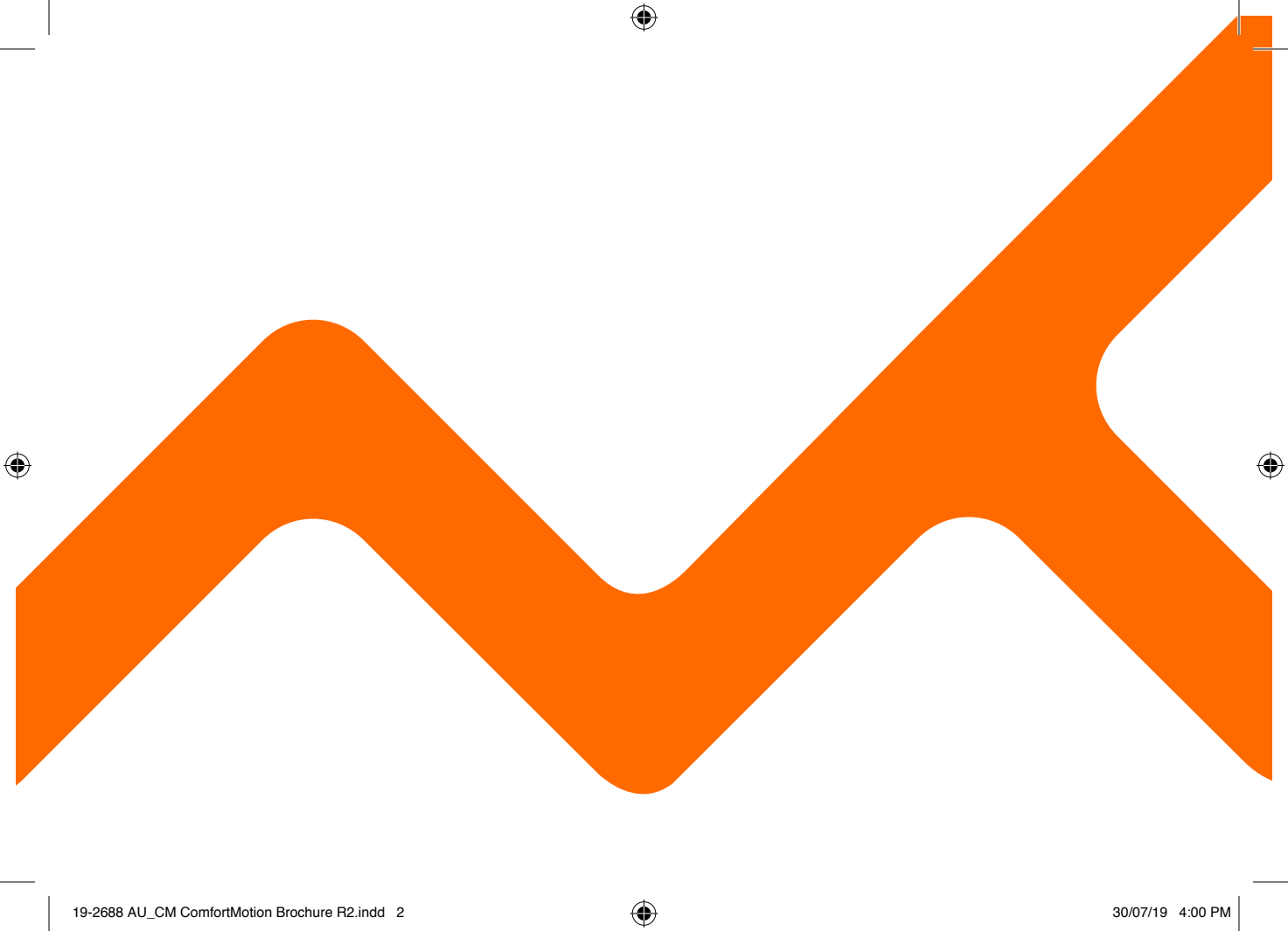







Contents:

Key safety information	4 - 7
Set-up guide - components	8 - 9
Set-up guide - instructions	10 - 15
Set-up guide - remote control	16-17
Testing your MotionComfort adjustable bed	18
Emergency backup battery	19
Troubleshooting	20





Key safety information about your MotionComfort bed - read prior to use

Congratulations on your purchase of a MotionComfort adjustable bed. This guide will provide you with all you need to know about assembling and using this product.

PLEASE READ THIS KEY SAFETY INFORMATION PRIOR TO USE AND ENSURE YOU KEEP THESE INSTRUCTIONS IN A SAFE PLACE FOR FUTURE REFERENCE.

SAFELY CONNECTING TO A POWER SUPPLY

- Place the MotionComfort adjustable bed on a flat, clean and dry surface.
- Ensure the base is properly connected to your power supply. It's recommended that you connect this product to a grounded surge protector (not included).
- Incorrect connection may cause electric shock or fire.
- Never use the product when any of the cords or electrical unit is damaged and keep all cords away from moving parts or any heated surfaces.
- If you need to move or clean this product, ensure all electrical functions are turned off before disconnecting from the wall outlet.
- If the motor or electronics of this product are damaged due to incorrect installation, the product warranty will be void.



The MotionComfort adjustable bed is for in-home use only and is not designed to be used as a hospital bed nor does it meet hospital standards. It should never be used with oxygen equipment or close to any explosive/flammable gases.

PETS AND SMALL CHILDREN

- Once unpacked, please dispose of all packaging immediately.
- Do not allow children or pets to play on or under the bed for their own safety.
- Never allow this product to be operated by a child without adult supervision.
- This product presents a risk of electric shock or injury if used incorrectly.

WEIGHT LIMITS

The recommended maximum weight limit for the MotionComfort adjustable bed (including the mattress weight which can vary depending on the mattress) is 320kg.

- The product will support these weight limits based on the weight being distributed evenly across the base.
- It is not designed to lift or support this amount in the head or foot sections alone and you should not enter or exit the bed with any part in the raised position.
- Do not sit on the head or foot sections while in a raised position.
- Any damage caused by exceeding these recommended maximum weight limits or use guidelines could damage the bed and void your warranty.

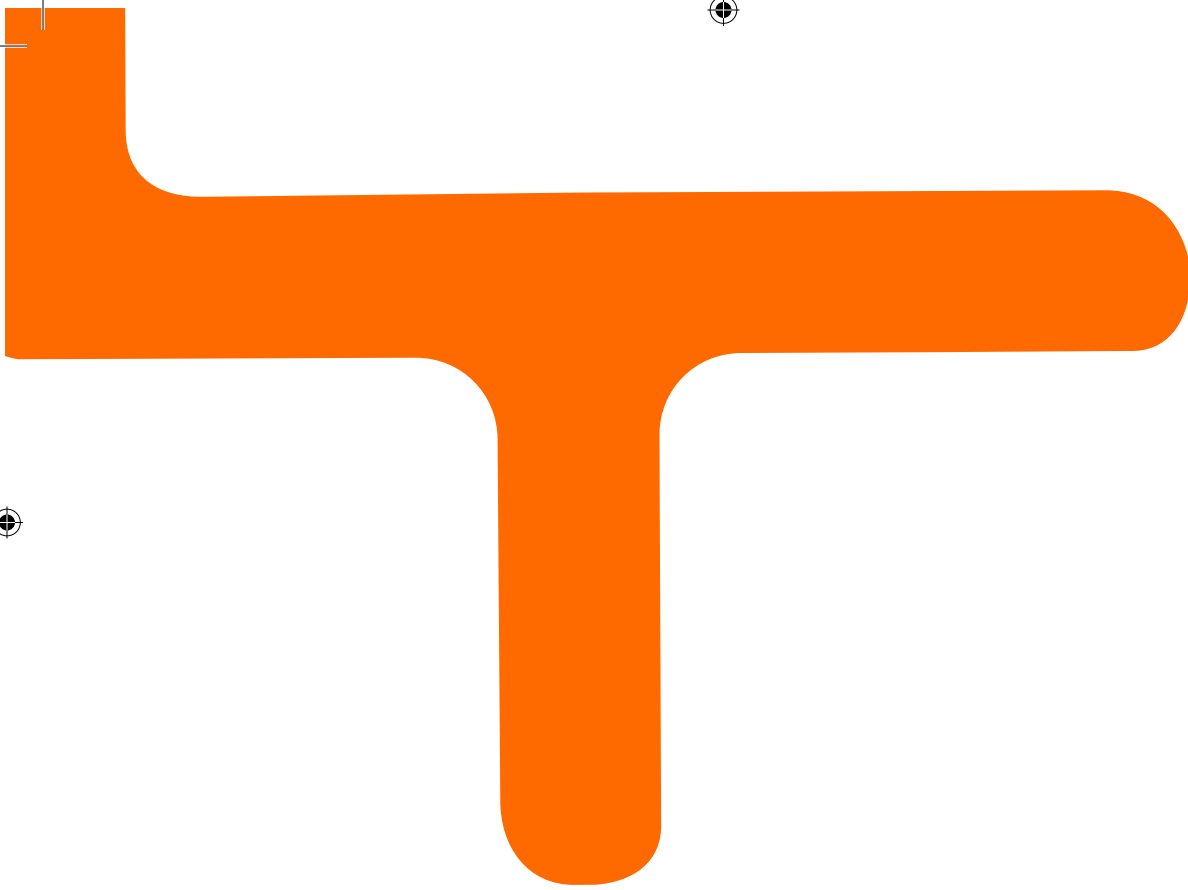

PRODUCT RATINGS

DO NOT MODIFY ANY PARTS OR COMPONENTS OF THE MotionComfort PRODUCT AND ONLY USE THIS PRODUCT AS DIRECTED IN THESE INSTRUCTIONS.

MOTOR RATINGS

MotionComfort motors are not designed to operate for more than two minutes within an eighteen minute time period. If these ratings are exceeded, this will impact the life of the motors and will void the warranty.

POWER RATINGS

INPUT: AC 100-240V-50/60HZ, 1.5 Amp

OUTPUT: DC 29V-2A

FUSE: 1.5A 250V

In the event of a short circuit, you should switch off and remove the plug from the wall socket. Please then seek assistance from a professionally qualified electrician.

DO NOT:

- Tamper with any of the motor components or control box.
- Alter or change any wiring.
- Modify the base or change the product in any way.

Any of the above will void the warranty.

SET-UP GUIDE - COMPONENTS

The base components include:

A. Bed base x 1 (packaged in 2 halves)



B. Retainer bar x 1



C. Transformer x 1



D. Wireless remote control x 1



E. Washers x 6 (single)
Washers x 8 (queen and above)



F. *Optional 8cm leg extenders /
Headboard mounting brackets



G. 15cm legs x 8



H. Power cord x 1



I. AAA battery x 3



J. Connecting bolt x 4 (long single)
x 8 (king single)



K. Allen key x 1



L. Connecting plate x 3



SET-UP GUIDE – ELECTRICAL COMPONENTS

THE MotionComfort ELECTRICAL COMPONENTS COME WITH A FULL 2 YEAR WARRANTY. WE WILL REPLACE ANY ELECTRONIC COMPONENTS WITHIN THAT TIME FROM THE DATE OF DELIVERY. MAINTENANCE AND REPAIRS WILL BE CARRIED OUT BY MotionComfort OR ONE OF OUR RECOMMENDED REPRESENTATIVES.

The electrical components include:

M. Black motor x 1

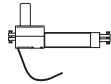

N. Foot motor x 1

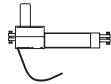

O. Transformer x 1



P. Control box x 1



Q. Cable x 1



R. Sync cable x1

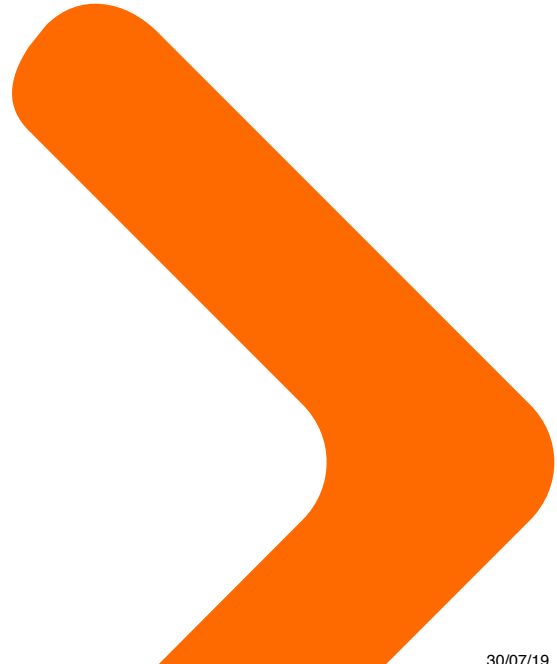



SET-UP GUIDE - INSTRUCTIONS

TO AVOID INJURY, PLEASE ENSURE THERE ARE TWO PEOPLE AVAILABLE TO INSTALL THE MotionComfort ADJUSTABLE BED.

Step 1

If installing headboard bracket (not supplied) please attach first.

Step 2

Place the box with the top facing up in the desired location.



Step 3

Check that the box contains all the components as specified in this guide before disposing of all the packaging. Note that some of the electronics may be within smaller boxes and attached to the base of the bed or frame.



SET-UP GUIDE - INSTRUCTIONS

Step 3

Slide the floor and head part of the bed base together ensuring that the holes are lined up.

Step 4

Align the holes on Bed base (A) with the Connecting plates (L) and secure with the Connecting bolts (J) using the allen key.

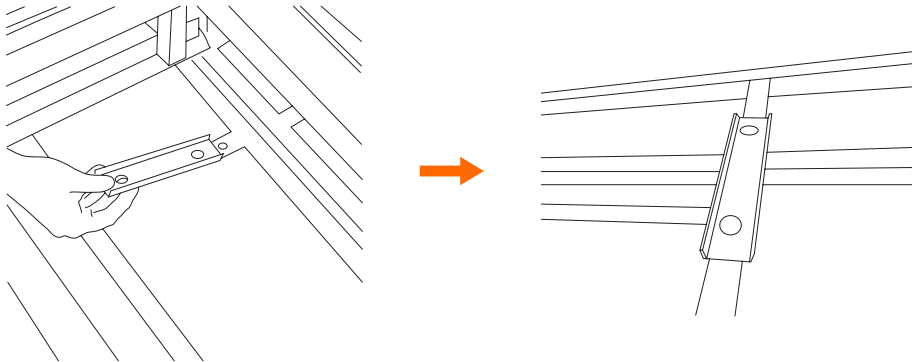



SET-UP GUIDE - INSTRUCTIONS

Step 5

Place a Washer (E) on the leg (G) and screw into the Bed base (A).

Step 6

Connect the Foot motor cable to the Foot motor input slot in the control box (on the underside of the Bed base)
- the cable and input slot are both labelled with a green sticker.

Making sure that the electrical inputs are all correctly connected ensures your MotionComfort adjustable bed functions well.



Note: When connecting two or more bases together, link their control boxes via the supplied sync cable to allow them to move together by using just one remote.



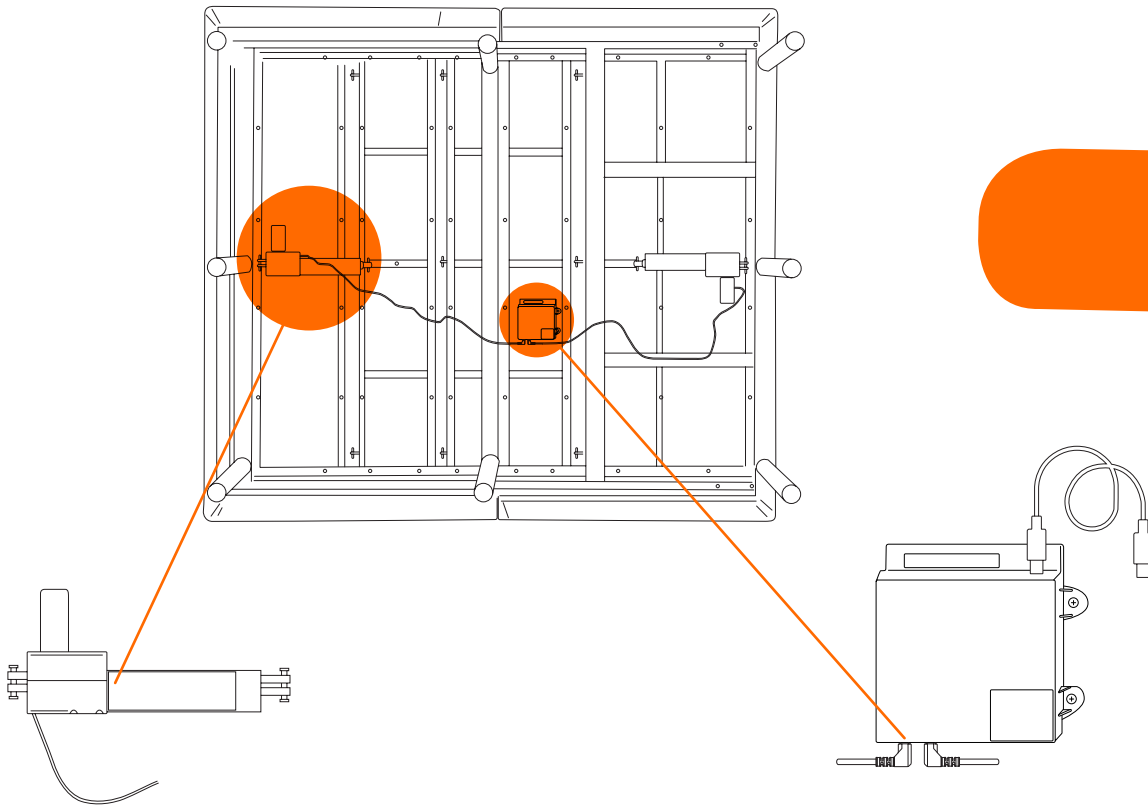

SET-UP GUIDE - INSTRUCTIONS

Step 8

Take the power cord that is attached to Bed base (A) and insert it into the Transformer (C). Then take Power cord (H) and insert it into the other side of the Transformer (C).

Step 9

Turn over the entire Bed base while holding onto the metal frame. Ensure there are two of you available to lift the base to avoid injury.

Step 10

Insert the Retainer bar (B) into the two holes that are on the foot end of your Bed base (A).

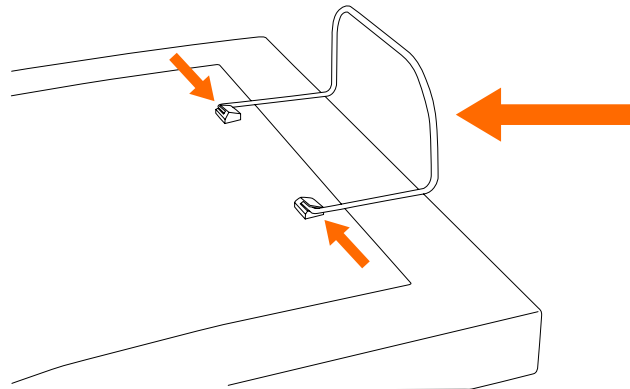



SET-UP GUIDE - REMOTE CONTROL

Step 11

Remove the battery cover on the Remote control (D) and insert the 3 x AAA batteries (I)

Note that all the functions of your MotionComfort adjustable bed are controlled by your Remote control (D) and it comes with some pre-programmed positions - the ZeroG and Flat buttons are the suggested bed positions from the manufacturer. No future programming is needed, and you can press any button on your remote to stop any motion in progress.

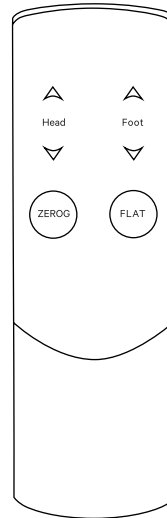



SET-UP GUIDE - REMOTE CONTROL

Your ComfortMotion base comes pre-paired. Follow the steps below if your remote becomes unpaired from your base.

Step 12 - pairing your remote control

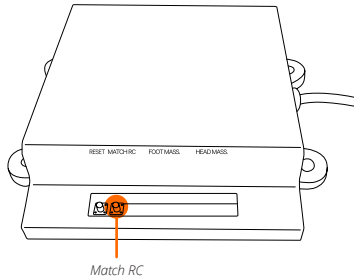
- I. Ensure that Power cord (H) is plugged into the wall so that there is power going to your ComfortMotion bed.
- II. Press and hold the 'Match RC' button on the control box for 3 seconds until the LED green light flashes.



- III. Press and hold the Head up  and Foot up  buttons at the same time. Once a blue light flashes on the Remote control, release the buttons.
- IV. This light will continue to flash until the Remote control has paired with the bed control box.
- V. When the light stops flashing the pairing has been successful and the remote and base will work together.
- VI. If the Remote control has not successfully paired, please check the batteries and repeat the above process.

TESTING YOUR MotionComfort ADJUSTABLE BED

To ensure you've got everything set up correctly, please test out all the bed's functions for three seconds using the remote before placing the mattress on the bed frame.

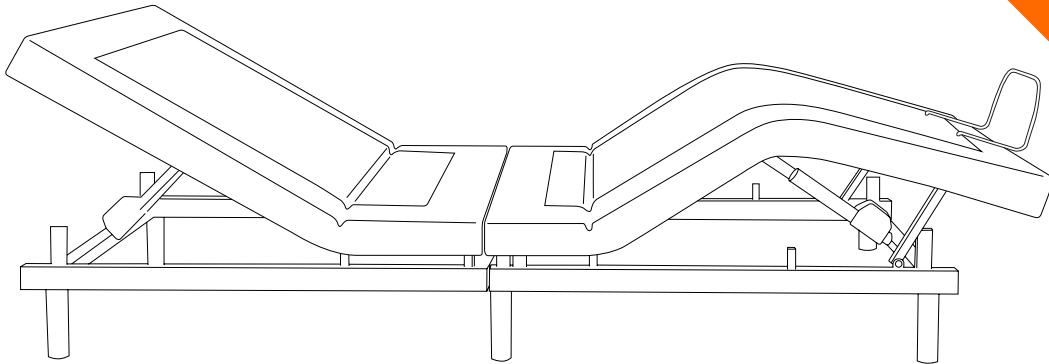

EMERGENCY BACKUP BATTERY

- In the event of a power cut, batteries can be used as a backup power source.
- You'll need to remove the power cord from your wall socket and open the battery cover at the back of the Transformer (C).
- Insert 2 x 9 V batteries (these are not included with your MotionComfort purchase).
- It's recommended that these are replaced every six months.
- Place the power cord back into the Transformer once you've installed the batteries.
- These emergency backup batteries are only to be used in the case of a power outage and not for the everyday use of the bed.

TROUBLESHOOTING

If any of the MotionComfort features stop working

- Ensure you turn off the product and unplug it from the socket.
- Check under the Bed base to ensure that the wired connections are secure and that none of the cords/and or bedding is obstructing the movement of the base.

If none of the MotionComfort features are working

- Check that the bed's power cord is properly connected and plugged in.
- Reset the bed by unplugging the mains power cord from the socket for 1 hour.
- Test the current socket outlet with a working appliance to ensure the issue is not with the power connection, if so, try another plug socket.
- We recommend that a grounded electrical surge protector is used with the MotionComfort adjustable bed.

If your Remote control stops working

- Firstly, check the 3 x AAA batteries have been placed in the unit correctly.
- Secondly, check that your Remote control has been successfully paired with the bed's control box (see page 11).

